



TACT SWITCH

P/N:TSL06131-0050

ILLUMINATED



SPECIFICATIONS

Function: Momentary action
 Contact Arrangement: SPST, Normally Open
 Termination: THD version

Mechanical

Actuation Force: 180±50grams
 Life Expectancy: 100,000 Operations

Electrical

Contact Rating: 50mA @ 12V DC
 Dielectric Strength: 250VAC for 1minute
 Contact Resistance: 100mΩ Max.
 Insulation Resistance: 100MΩ Min.
 Travel: 0.25±0.1mm

Environmental

Operating Temperature: -25~+70°C
 Relative Humidity: (40°C) ≤95%

Materials

6.CAP: GP.ABS
 5.LED: Red<=>White
 4.Stem: White GP.PA66
 3.Contact: Stainless Steel with Silver cladding
 2.Holder: Black GP.PA66
 1.Terminal: Copper (H62Y t=0.3) with Silver Cladding

Packaging

Bulk Package
 Inner Package: Plastic bag
 Outer Package: Carton

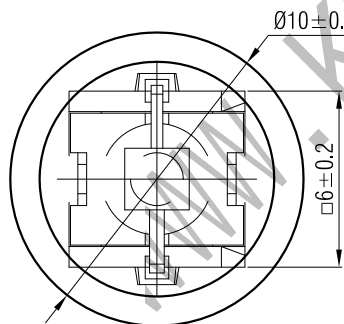
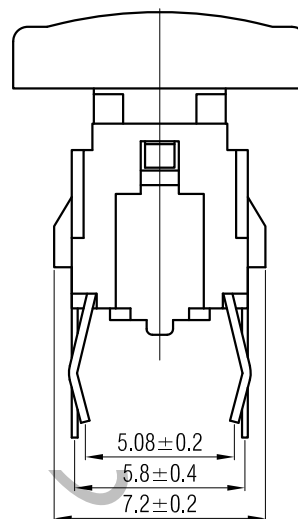
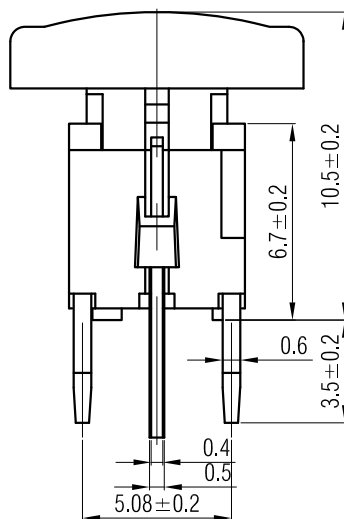

CIRCUIT DIAGRAM

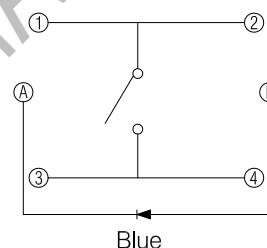

LED

P.C.B. LAYOUT

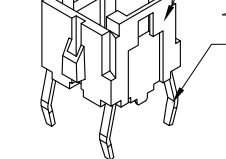
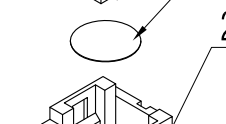
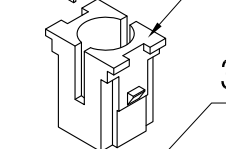
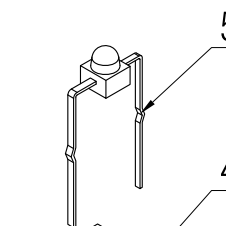
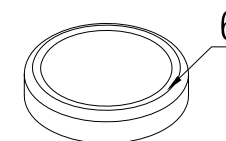
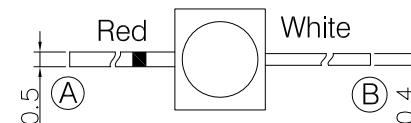
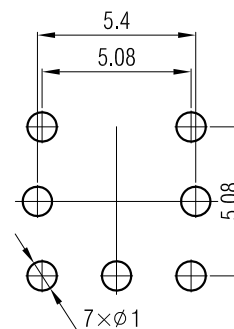

KHAN ELECTRONIC

VERSION		PROJECTION		DESIGN	AO YU DA
KH14FE22E				DRAWN	AO YU DA
SCALE	SIZE	Dimensions are shown:mm(inches)		APPROVAL	XU JUN HUI
4:1	A4	2018.09.21			